

## CBU-A2D

Bluetooth controllable 2ch 0-10V/DALI controller

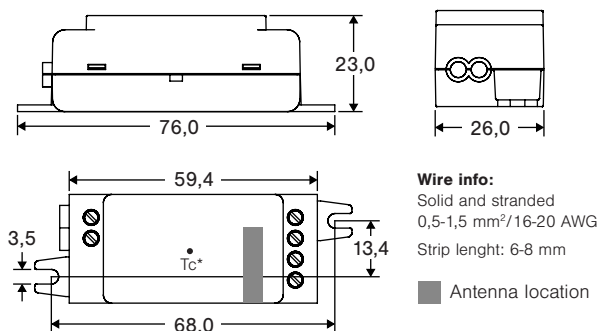



### Dimensions



Dimensions are in mm. \* Tc point is on bottom side



**Warning!**  
Hazardous voltages. Risk of electric shock or fire. Only qualified professionals should make the connections. Disconnect the mains power supply and verify its absence prior to installation.

### Description

CBU-A2D is a Bluetooth controllable, Casambi enabled 2-channel 0-10V/DALI controller. The product can be configured to different operation modes. CBU-A2D has a universal 100-277 VAC input voltage range.

CBU-A2D can control one or two 0-10V controllable LED drivers, or it can control a tunable white LED driver with two 0-10V control interfaces. The product can also be configured into a DALI mode where it can be connected to a DALI LED driver or DALI sensor for presence and/or daylight harvesting functions.

CBU-A2D can be controlled with Casambi app which can be downloaded free of charge from Apple App Store and Google Play Store.

Different Casambi enabled products can be used from a simple one luminaire direct control to a complete and full featured light control system where up to 250 units form automatically an intelligent mesh network.

With Standalone DALI output, CBU-A2D acts both as a controller and as a power supply making it possible to connect directly to an LED driver with DALI interface without the need for an external DALI power supply. This so-called Standalone DALI makes it possible to implement multi-channel lighting systems with adjustable color (RGB and RGBW) or color temperature (CCT), while keeping the wiring and number of components at their minimum.

## Installation

Make sure that the mains voltage is switched off when making any connections. Use 0.5-1.5 mm<sup>2</sup> solid or stranded conductor electrical wires. Strip the wire 6-7 mm from the end. Insert the wires into the corresponding holes and tighten the connector screws to 0,4 Nm.

If the connected LED driver cannot be turned off completely from the control interface, an external relay with 12 VDC coil can be connected to channel 2. Make sure the relay is protected against flyback voltage, e.g. do not use a PCB relay without the flyback diode. A suitable fixture configuration must be selected in order to control a relay.

CBU-A2D, as any other Casambi product, should not be placed in a metal enclosure or next to large metal structures. Metal will effectively block radio signals which are crucial to the operation of the product. A thorough connectivity testing is strongly recommended in the installation site.

### Compatible devices:

Phone iOS 10 and later are supported  
 iPad iOS 10 and later are supported  
 Android 4.4 version (KitKat) and later are supported



### Wiring diagram, one driver and relay

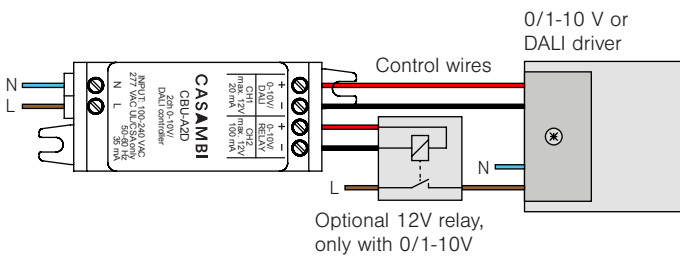

### Wiring diagram, 2 channel LED driver

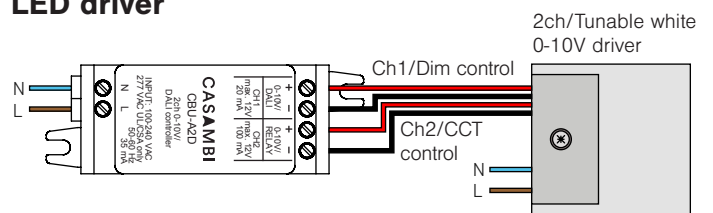

### Wiring diagram, two drivers (only 0-10V)

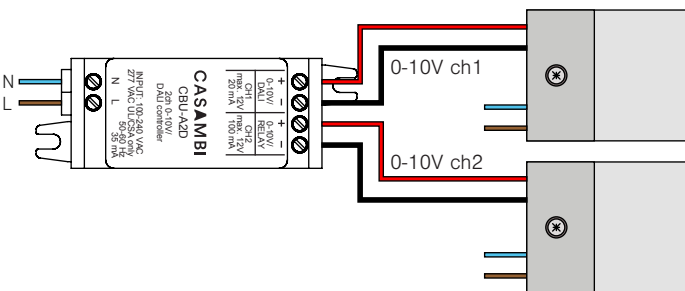

### Wiring diagram, DALI sensor

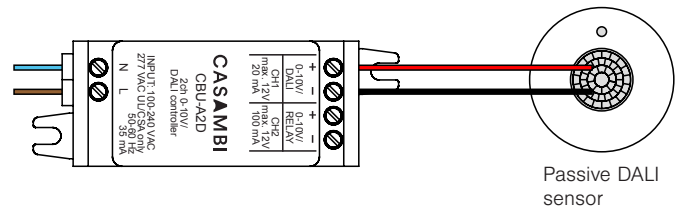

### Wiring diagram, Push Button

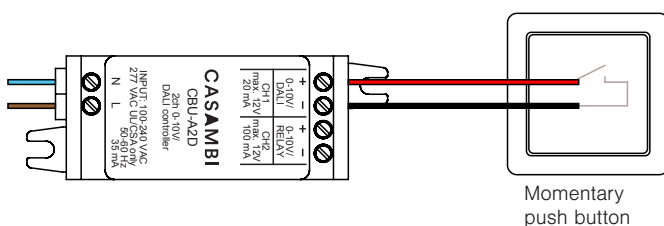

### Warning!

Do not connect the output channels in parallel. This may cause permanent damage to the product.

## Technical data

### Input

Voltage range:	100-240 VAC
Frequency:	50-60 Hz
Max. mains current:	35 mA
No-load standby power:	< 0,5 W

### Channel 1 output

Output voltage,	0-10V: 0-10 VDC, max. 7 mA (sinking)
Output voltage, DALI:	12 VDC, max. 20 mA (sourcing)
Maximum number of drivers:	1 driver or 1 sensor/push button

### Channel 2 output

Output voltage, 0-10V:	0-10 VDC, max. 7 mA (sinking)
Output voltage, relay control:	12 VDC, max. 100 mA (sourcing)
Maximum number of drivers:	1

### Radio transceiver

Operating frequencies:	2400-2480 MHz
Maximum output power:	+4 dBm

### Operating conditions

Ambient temperature, ta:	-20...+45 °C
Max. case temperature, tc:	+70 °C
Storage temperature:	-25...+70 °C
Max. relative humidity:	0...80%, non-condensing

### Connectors

Wire range, solid & stranded:	0,5-1,5 mm <sup>2</sup> / 20 -16 AWG
Wire strip length:	6-7 mm
Tightening torque:	0,4 Nm/4 Kgf.cm

### Mechanical data

Dimensions:	76,0 x 26,0 x 23,0 mm
Weight:	40 g
Degree of protection:	IP20 (indoor use only)
Protection class:	Built-in Class II

FCC ID:	2ALA3-CBUA2D
IC:	22496-CBUA2D
UL:	E494741

## Range

The range between two CBU-A2D units or between a CBU-A2D and a smart phone can vary a lot depending on obstacles and surrounding material. In open air, the range between two CBU-A2Ds can be in excess of 50m, but if the unit is incorporated into a metal structure the range can be only few feet. Therefore, thorough testing is highly suggested.

Casambi uses mesh network technology so each CBU-A2D acts also as a repeater. When testing the network, it is important to test that all mesh network nodes are visible to at least one other node – thereby confirming that all network devices appear active.

## Dimming without app

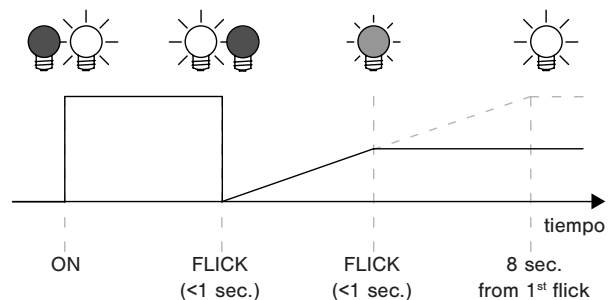

1. Turn lights on from a wall switch.
2. Quickly flick the wall switch off (max. 1 sec.) and back on. The light level starts to increase gradually.
3. Flick the switch again at desired dim level. The selected level is saved automatically.
4. If the second flick is not done within 8 sec. the light intensity reaches its maximum level.
5. Flicking the switch can also be used to switch between predefined scenes.

## Fixture profile

Type	Profile #	Profile	Description
0-10V	11503 *	0-10V 2CH Dim, Temp (NoMix)	Two-channel 0-10V dimmer for tuneable white. Note that this mode does not perform warm/cool mixing, but directly sends dimmer value to output 0 and temperature value to output 1.
	11501	0-10V TW	Two channel warm/cool mixer.
	11508	0-10V (on/off)	Basic one channel 0-10V dimmer.
	11509	0-10V (PB)	Basic one channel 0-10V dimmer.
	11499	0-10V + Relay	Basic one channel 0-10V dimmer.
	11500	2CH 0-10V	Two-channel 0-10V dimmer.
	11504	2CH Dim,Vertical	Two-channel luminaire with dimmers and vertical ratio selector (sum of channels is same as dim level)
Control	11507	PushButton + Relay	CBU-A2D with low voltage push button connected to Analog / Digital dimming interface. Relay can be controlled with ON/OFF custom element.
DALI	11513	DALI 2CH	Two channel luminaire. Dimmer #1: address #0 dimmer #2: address #1
	11514	DALI 8CH	Four channel luminaire. Dimmer #1: address #0 Dimmer #2: address #1 Dimmer #3: address #2 Dimmer #4: address #3
	11510	DALI/BC/Sensors	Basic DALI broadcast dimmer, no short addressing required.
	11520	DALI DT8 RGB/TW	DALI DT8 dimmer with mutually exclusive RGB or TC (color temperature) controls.
	11512	DALI DT8 TW	Dimmer with tuneable white for CBU-ASD with DALI DT8 driver supporting TC color model: warm/cool mixing is done by DALI driver, and CBU-ASD sets dimlevel and temperature values.
	12115	DALI DT8 XY/TW (Evo)	Multichannel DALI DT8 dimmer supporting 'XY' color-type control
	11511	DALI TW	Two channel warm/cool mixer.

\*Default profile