

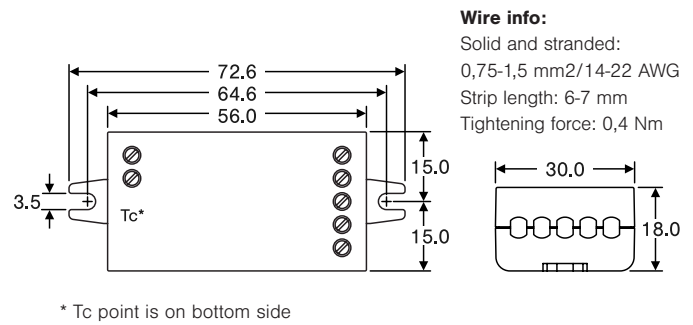

CBU-PWM4

Bluetooth controllable 4ch PWM dimmer



Dimensions





Warning!
 Hazardous voltages. Risk of electric shock or fire. Only qualified professionals should make the connections. Disconnect the mains power supply and verify its absence prior to installation.



Description

CBU-PWM4 is a Bluetooth controllable, Casambi enabled four channel PWM dimmer for constant voltage LED loads, such as LED strips and constant voltage LED modules. It is connected between a 12-24 VDC power supply and the constant voltage LED load.

CBU-PWM4 can control up to four channels making it an ideal partner for RGBW and tunable white (TW) applications. The maximum total output current is 6 A which can be freely divided between 1-4 channels. CBU-PWM4 is protected against overvoltage, overcurrent and short circuit situations. CBU-PWM4 is not protected against reverse polarity!

CBU-PWM4 can be controlled with Casambi app which can be downloaded free of charge from Apple App Store and Google Play Store.

Different Casambi enabled products can be used from a simple one luminaire direct control to a complete and full featured light control system where up to 250 units form automatically an intelligent mesh network.

Installation

Connect a constant voltage 12-24 VDC double insulated power supply to the input connector. Make sure not to use a constant current LED driver and make sure that the cable polarity is correct.

The product has one shared positive output connector (+) and each of the four channels have its own negative connector (-). This is the most typical case with multichannel LED strips. Connect the LED load wires accordingly. Please note, most led strips will permanently damage if reverse polarity.

CBU-PWM4 can be configured having different types of outputs, such as 4 channel RGBW, 3 channel RGB or 2 channel TW. Also, it is possible to configure 1-4 jointly and individually dimmable channels. These configurations can be made by the end user from Casambi App.

As default, CBU-PWM4 is delivered with RGBW configuration.

CBU-PWM4, as any other Casambi product, should not be placed in a metal enclosure or next to large metal structures. Metal will effectively block all radio signals which are crucial to the operation of the product.

Wiring diagram, RGBW

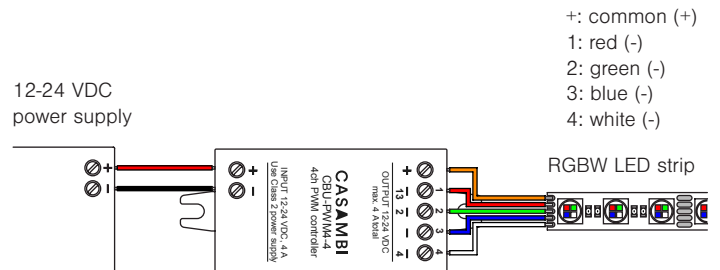

Wiring diagram, tunable white

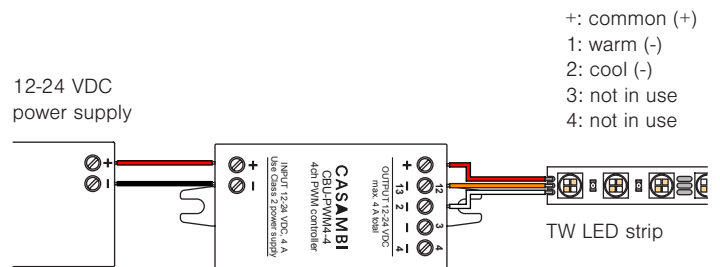

Wiring diagram, 1-4 separate channels

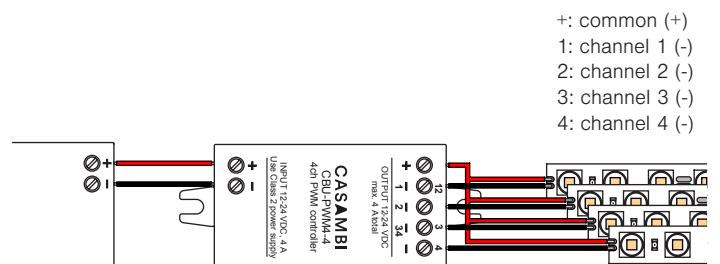

Technical data

Input

Voltage range:	12-24 VDC
Max. input current:	6 A
No-load standby power:	< 0,3 W

Output

Output voltage:	same as input voltage
Max. output power:	144 W @ 24 VDC 72 W @ 12 VDC
Max. output current:	6 A (can be freely divided between the channels)
Min. load requirement:	0 W
Dimming method:	Pulse Width Modulation (PWM)

Radio transceiver

Operating frequencies:	2400-2480 MHz
Maximum output power:	+4 dBm

Operating conditions

Ambient temperature, ta:	-20...+45°C
Max. case temperature, tc:	+75°C
Storage temperature:	-25...+75°C
Max. relative humidity:	0...80%, non-cond.

Connectors

Wire range, solid & stranded:	0,75 - 1,5 mm ² 14 - 22 AWG
Wire strip length:	6 - 7 mm
Tightening force:	0,4 Nm
Maximum input cable length:	3 m
Recommended load cable length:	max 3m

Mechanical data

Dimensions:	72,6 x 30,0 x 18,0 mm
Weight:	23 g
Degree of protection:	IP20 (indoor use only)

Range

Compatible devices:

iPhone iOS 10 and later are supported
 iPad iOS 10 and later are supported
 Android 4.4 version (KitKat) and later are supported

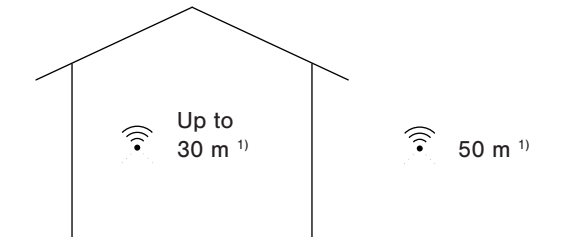

Casambi uses mesh network technology so each Casambi unit, or Casambi Ready product, acts also as a repeater. Longer ranges can be achieved by any using Casambi unit as a repeater.

1) Range is highly dependant on the surrounding and obstacles, such as walls and building materials.

Disposal Instructions

In line with EU Directive 2002/96/EC for waste electrical and electronic equipment (WEEE), this electrical product must not be disposed of as unsorted municipal waste. Please dispose of this product by returning it to the point of sale or to your local municipal collection point for recycling.

Fixture profile

Profile #	Profile	Description
8122	1xDIM	Basic one channel PWM dimmer.
4031	2xDIM	Two channel PWM dimmer.
4032	3xDIM	Three channel luminaire.
4033	4xDIM	Four channel luminaire. Note that zeroDetect, if used, must be on 'High when present' mode.
4029	RGB	Three channel RGB PWM dimmer.
5037	RGB 625Hz	Three channel RGB PWM dimmer.
4885	RGB/White	Four channel RGB fixture with White. The ratio between RGB and White is selected with mixer.
4027*	RGBW	Four channel RGB fixture with White. RGB is always present but amount of White be adjusted.
4887	Sliders/RGBW	Fixture using PWM channels with custom elements. This fixture provides a dimmer control but it does not consume PWM channel; it will be only used to multiply the output of selected custom elements.
4030	TW	Two channel warm/cool mixer.
8331	TW (WW-CW dimmer)	Single dimmer controlling two output channels. This can used to implement, for example, warm dimming or constant current solution where changing voltage and PWM based dimming techniques are combined together.
8280	3CH (White, Cold, Warm)	Three channel luminaire with simulated tuneable-white effect for dimmer and color temperature

*Default profile

Notes